



Kanalguss-Zubehör

Schmutzfänger

Seite 1 bis 3



Schlammmeimer

Seite 4 bis 9

Zubehör

Seite 10 bis 12

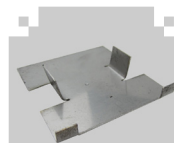

Kontakt

E. Raiss GmbH + Co. Baustoffhandel KG
Seiffenensdorfer Str. 10a, 02794 Leutersdorf
☎ 0 35 86 / 78 13 0 📠 0 35 86 / 78 13 28
✉ leutersdorf@raiss-baustoffe.de





Schmutzfänger leicht, ähnl. DIN 1221

Schmutzfänger, leichte Ausführung
ähnl. DIN 1221

aus feuerverzinktem Stahlblech

48 Stk./Pal



4 2 6 0 2 4 5 0 8 1 7 0 7



Schmutzfänger schwer, ähnl. DIN 1221

Schmutzfänger, schwere Ausführung
ähnl. DIN 1221

aus feuerverzinktem Stahlblech

36 Stk./Pal



4 2 6 0 2 4 5 0 8 1 7 1 4



Schmutzfänger nach DIN 1221

Schmutzfänger DIN 1221
aus feuerverzinktem Stahlblech

≥ 7,2kg, mit erforderlichem
Stempel gekennzeichnet

36 Stk./Pal



4 2 6 0 2 4 5 0 8 1 7 2 1



Schmutzfänger schwer NW800, ähnl. DIN 1221

Schmutzfänger NW800
schwere Ausführung, ähnl. DIN 1221
für die Verwendung in
Schachtabdeckungen NW800

aus feuerverzinktem Stahlblech

36 Stk./Pal



4 2 6 0 2 4 5 0 8 1 9 1 2

Kontakt

E. Raiss GmbH + Co. Baustoffhandel KG
Seihennersdorfer Str. 10a, 02794 Leutersdorf
☎ 0 35 86 / 78 13 0 📠 0 35 86 / 78 13 28
✉ leutersdorf@raiss-baustoffe.de



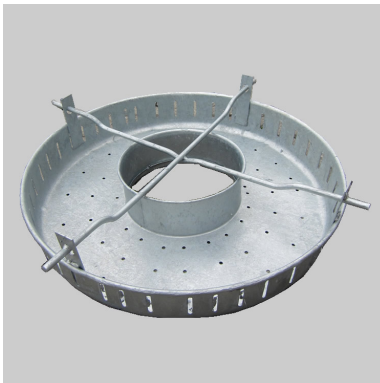

Ringschmutzfänger leicht, ähnl. DIN 1221

Ringschmutzfänger, leichte Ausführung
ähnl. DIN 1221

aus feuerverzinktem Stahlblech

36 Stk./Pal

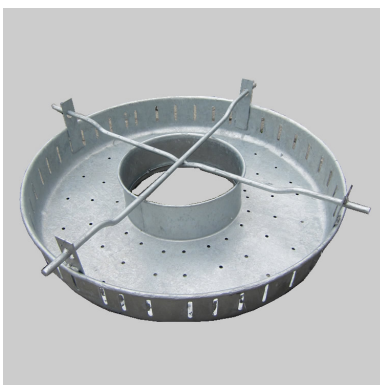

Ringschmutzfänger schwer, ähnl. DIN 1221

Ringschmutzfänger, schwere Ausführung
ähnl. DIN 1221

aus feuerverzinktem Stahlblech

36 Stk./Pal

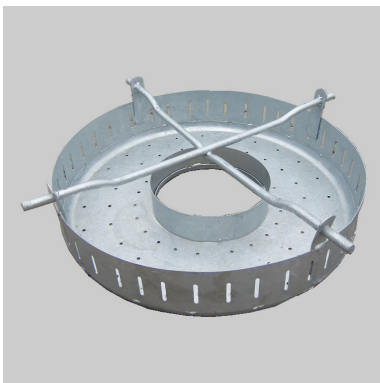

Ringschmutzfänger ähnl. DIN 1221 „Düsseldorfer Modell“

Ringschmutzfänger „Düsseldorfer Modell“
schwere Ausführung, ähnl. DIN 1221,

aus feuerverzinktem Stahlblech

36 Stk./Pal



Kontakt

E. Raiss GmbH + Co. Baustoffhandel KG
Seiffhennersdorfer Str. 10a, 02794 Leutersdorf
☎ 0 35 86 / 78 13 0 📠 0 35 86 / 78 13 28
✉ leutersdorf@raiss-baustoffe.de





Schmutzfänger schwer, ähnl. DIN 1221 - Viatop

Schmutzfänger Viatop
schwere Ausführung, ähnl. DIN 1221

mit verlängerten Auflegewinkeln

aus feuerverzinktem Stahlblech

36 Stk./Pal



Schmutzfänger leicht, ähnl. DIN 1221 - Viatop

Schmutzfänger Viatop
leichte Ausführung, ähnl. DIN 1221

mit verlängerten Auflegewinkeln

aus feuerverzinktem Stahlblech

36 Stk./Pal



Schmutzfänger schwer, ähnl. DIN 1221, PE-HD

Schmutzfänger schwere Ausführung
ähnl. DIN 1221

aus PE-HD

36 Stk./Pal



Kontakt

E. Raiss GmbH + Co. Baustoffhandel KG
Seiffenensdorfer Str. 10a, 02794 Leutersdorf
☎ 0 35 86 / 78 13 0 📠 0 35 86 / 78 13 28
✉ leutersdorf@raiss-baustoffe.de



Schlammeimer A2, ähnl. DIN 4052

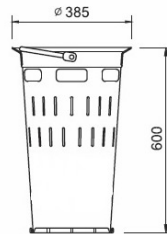

NW450mm, rund, lang

aus feuerverzinktem Stahlblech

36 Stk./Pal



Schlammeimer A4, ähnl. DIN 4052

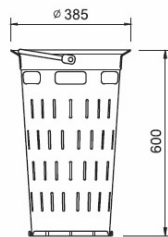

NW450mm, rund, lang

aus feuerverzinktem Stahlblech

36 Stk./Pal



Schlammeimer B1, ähnl. DIN 4052

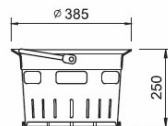

NW450mm, rund, kurz

aus feuerverzinktem Stahlblech

60 Stk./Pal



Schlammeimer C2, ähnl. DIN 4052

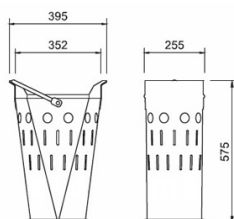

NW450mm, oval, lang

aus feuerverzinktem Stahlblech

40 Stk./Pal



Kontakt

E. Raiss GmbH + Co. Baustoffhandel KG
 Seiffenensdorfer Str. 10a, 02794 Leutersdorf
 ☎ 0 35 86 / 78 13 0 📠 0 35 86 / 78 13 28
 ✉ leutersdorf@raiss-baustoffe.de



Schlammeimer C3, ähnl. DIN 4052

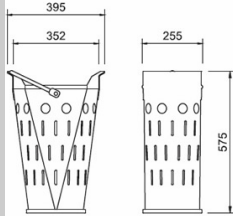

NW450mm, oval, lang

aus feuerverzinktem Stahlblech

40 Stk./Pal



Schlammeimer D1, ähnl. DIN 4052

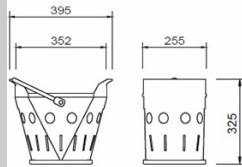

NW450mm, oval, kurz

aus feuerverzinktem Stahlblech

52 Stk./Pal



Hofeimer kurz, ähnl. DIN 1236

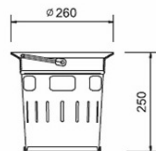

NW300mm, rund, kurz

aus feuerverzinktem Stahlblech

100 Stk./Pal



Hofeimer lang, ähnl. DIN 1236

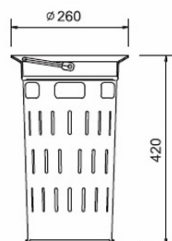

NW300mm, rund, lang

aus feuerverzinktem Stahlblech

60 Stk./Pal



Kontakt

E. Raiss GmbH + Co. Baustoffhandel KG
Seiffenhensdorfer Str. 10a, 02794 Leutersdorf
☎ 0 35 86 / 78 13 0 📠 0 35 86 / 78 13 28
✉ leutersdorf@raiss-baustoffe.de



Schlammeimer A2, DIN 4052

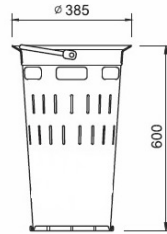

NW450mm, rund, lang
aus feuerverzinktem Stahlblech

≥ 8,5kg, mit erforderlichem
Stempel gekennzeichnet

36 Stk./Pal



Schlammeimer A4, DIN 4052

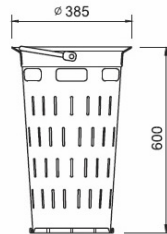

NW450mm, rund, lang
aus feuerverzinktem Stahlblech

≥ 8,3kg, mit erforderlichem
Stempel gekennzeichnet

36 Stk./Pal



Schlammeimer B1, DIN 4052

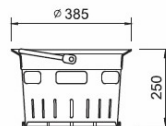

NW450mm, rund, kurz
aus feuerverzinktem Stahlblech

≥ 5,4kg, mit erforderlichem
Stempel gekennzeichnet

60 Stk./Pal



Schlammeimer C2, DIN 4052

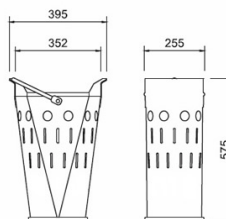

NW450mm, oval, lang
aus feuerverzinktem Stahlblech

≥ 7,7kg, mit erforderlichem
Stempel gekennzeichnet

40 Stk./Pal



Kontakt

E. Raiss GmbH + Co. Baustoffhandel KG
Seiffenhensdorfer Str. 10a, 02794 Leutersdorf
☎ 0 35 86 / 78 13 0 📠 0 35 86 / 78 13 28
✉ leutersdorf@raiss-baustoffe.de



Schlammeimer C3, DIN 4052

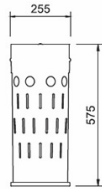

NW450mm, oval, lang
aus feuerverzinktem Stahlblech

≥ 7,6kg, mit erforderlichem Stempel
gekennzeichnet

40 Stk./Pal



Schlammeimer D1, DIN 4052

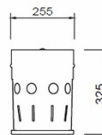

NW450mm, oval, kurz
aus feuerverzinktem Stahlblech

≥ 5,4kg, mit erforderlichem Stempel
gekennzeichnet

52 Stk./Pal



Kontakt

E. Raiss GmbH + Co. Baustoffhandel KG
Seiffenensdorfer Str. 10a, 02794 Leutersdorf
☎ 0 35 86 / 78 13 0 📠 0 35 86 / 78 13 28
✉ leutersdorf@raiss-baustoffe.de



Schlammeimer A4, ähnl. DIN 4052, PE-HD

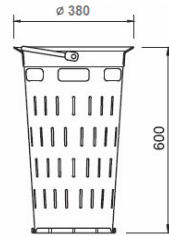

NW450mm, rund, lang
aus PE-HD

36 Stk./Pal



Schlammeimer B1, ähnl. DIN 4052, PE-HD

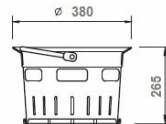

NW450mm, rund, kurz
aus PE-HD

60 Stk./Pal



Schlammeimer D1, ähnl. DIN 4052, PE-HD

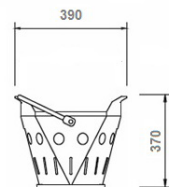

NW450mm, oval, kurz
aus PE-HD

52 Stk./Pal



Kontakt

E. Raiss GmbH + Co. Baustoffhandel KG
Seiffenensdorfer Str. 10a, 02794 Leutersdorf
☎ 0 35 86 / 78 13 0 📠 0 35 86 / 78 13 28
✉ leutersdorf@raiss-baustoffe.de



Hofeimer kurz, ähnl. DIN 1236, PE-HD

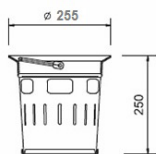

NW300mm, rund

aus PE-HD

120 Stk./Pal



Hofeimer lang, ähnl. DIN 1236, PE-HD

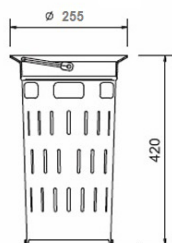

NW300mm, rund

aus PE-HD

60 Stk./Pal



Kontakt

E. Raiss GmbH + Co. Baustoffhandel KG
Seiffenensdorfer Str. 10a, 02794 Leutersdorf
☎ 0 35 86 / 78 13 0 📠 0 35 86 / 78 13 28
✉ leutersdorf@raiss-baustoffe.de





Steigbügel aus Stahl, Form A

Steigbügel Form A, DIN 19555
aus Stahl, PE ummantelt, schwarz



Steigbügel aus Stahl, Form B

Steigbügel Form B, DIN 19555
aus Stahl, PE ummantelt, schwarz



Steigbügel aus Edelstahl, Form A

Steigbügel Form A, DIN 19555
aus Edelstahl, PE ummantelt, orange



Steigbügel aus Edelstahl, Form B

Steigbügel Form B, DIN 19555
aus Edelstahl, PE ummantelt, orange



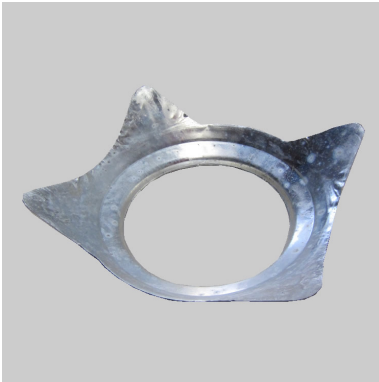

Trichter verzinkt

Trichter für Aufsätze

verzinkt

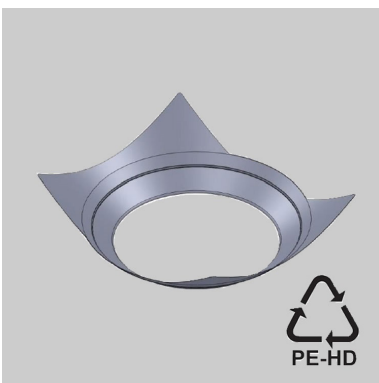

Trichter PE-HD

Trichter aus PE-HD

für Aufsätze



Gusstrichter

Gusstrichter für Muldeneinläufe



Verschlussbleche

Verschlussbleche für Aufsätze

aus Edelstahl



Kontakt

E. Raiss GmbH + Co. Baustoffhandel KG
Seiffenhensdorfer Str. 10a, 02794 Leutersdorf
☎ 0 35 86 / 78 13 0 📠 0 35 86 / 78 13 28
✉ leutersdorf@raiss-baustoffe.de





Aushebehaken kurz

Aushebehaken verzinkt

kurz, mit Griff
Länge: 20cm



Aushebehaken lang

Aushebehaken verzinkt

lang, mit Griff
Länge: 60cm



Aushebe- und Bedienschlüssel

Aushebe- und Bedienschlüssel „Kreuz“



Bedienschlüssel

Bedienschlüssel, verzinkt

Länge: 40cm



Kontakt

E. Raiss GmbH + Co. Baustoffhandel KG
Seiffenensdorfer Str. 10a, 02794 Leutersdorf
☎ 0 35 86 / 78 13 0 📠 0 35 86 / 78 13 28
✉ leutersdorf@raiss-baustoffe.de



Kontakt

E. Raiss GmbH + Co. Baustoffhandel KG
Seifhennersdorfer Str. 10a, 02794 Leutersdorf
☎ 0 35 86 / 78 13 0 📠 0 35 86 / 78 13 28
✉ leutersdorf@raiss-baustoffe.de

